

Water- and Environment-resistive FA Connectors Save Wiring and Maintenance Effort

- Compact FA connectors meet IP67 requirements and ensure a 94V-0 fire retardant rating.
- A wide array of connectors makes a wiring system more modular, simplifies maintenance, and reduces downtime.
- Connectors with Cables and Connector Assemblies are available.
- Three types of Connector Assembly: Crimping, soldering, and screw-on.
- Connectors with Cables are UL certified.
- Based on IEC61076-2-101 (IEC60947-5-2) and NECA 4202.







 Refer to *Safety Precautions* on page 21.

Ratings and Specifications

Rated current	4A
Rated voltage	250 VAC/VDC
Contact resistance (Connector)	40 mΩ max. (20 mV max., 100 mA max.)
Insulation resistance	1,000 MΩ min. (at 500 VDC)
Dielectric strength (Connector)	1,500 VAC for 1 min (leakage current: 1 mA max.).
Degree of protection	IP67 (IEC60529)
Insertion tolerance	200 times
Cable holding strength	Cable diameter: 6 mm 98 N/15 s 4 to 5 mm 49 N/15 s 3 mm 29 N/15 s
Ambient operating temperature range	Operating: - 25°C to 70°C *
Ambient humidity range	20% to 85%

*Use the robot cable within a temperature range between 0°C and 70°C to prevent the wires inside the cable from being broken when bending it.

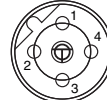
Socket Appearance

DC type		AC type	
Male (plug) contacts	Female (socket) contacts	Male (plug) contacts	Female (socket) contacts
			











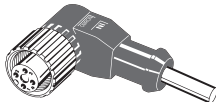

Note: The AC and DC connectors are different as shown here and therefore cannot be connected together.

Materials and Finish

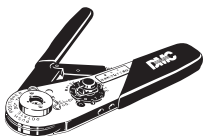
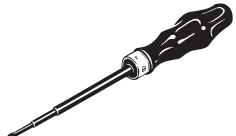
Item		XS2F/H/W	XS2F-LED	XS2M/R/P	XS2C/G
Contacts	Materials	Phosphor bronze		Brass	
	Finish	Nickel base, 0.4-μm gold plating			
Thread bracket	Materials	Brass *			
	Finish	Nickel plated *			
Pin block	Materials	PBT resin (UL94V-0)		PA resin (UL94V-0)	PBT resin (UL94V-0)
	Finish	For DC: light gray; for AC: dark gray			
O-ring/rubber bushing		Rubber			
Cover		Soft PBT resin (UL94V-0)	TPU resin (UL94HB)	---	PBT resin (UL94V-0)
Cable	Fire-retardant, Robot cable	UL AWM2464 CL3, 6 mm dia. AWG20 (0.5mm ²) Structure: 0.08 mm/110 wires		---	---
	Non-polar DC Connectors with Standard Cable	6 mm dia. AWG20 (0.5mm ²) Structure: 0.12 mm/45 wires		---	---
	E2E models with conventional connector pin with Fire-retardant, Robot cable	UL AWM2464 CL3, 6 mm dia. AWG20 (0.5mm ²) Structure: 0.08 mm/110 wires		---	---
	Heat-resistant cable up to 105°C	6 mm dia. AWG20 (0.5mm ²) Structure: 0.12 mm/45 wires		---	---
	Spatter-resistant Cables	6.6 mm dia. AWG20 (0.5mm ²) Structure: 0.08 mm/110 wires		---	---
	Standard Cable (XS2F-LED)	---	UL AWM2464 5.0 mm dia. (3 conductors) 5.4 mm dia. (4 conductors) 0.34 mm ² Structure: 0.1 mm/43 wires		---

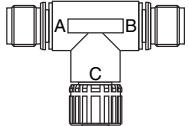
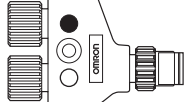
*The T-joint of the XS2R is aluminum/white.

List of Products

Name	Model		Appearance
1. Connectors attached to Cable	XS2W Sockets and Plugs on Cable Ends		
	XS2F Sockets on One Cable End		
	XS2F Sockets on One Cable End with Indicator		
	XS2H Plugs on One Cable End		
2. Connector Assemblies (Crimping, Soldering, or Screw-on) Used to enable using connectors for sensor cables and relay cables.	XS2G Plug Assemblies		
	XS2C Socket Assemblies		
	XY2F Crimp Tool (for Crimping Connectors)		
	XW4Z Screwdriver (for Screw-on Connectors)		
3. Terminal Box Connectors Used to enable using connectors for terminal boxes.	XS2P Panel-mounting Sockets		
4. T-Joints and Y-Joints Used for branching and for daisy-chain connections.	XS2R T-Joint/Y-Joint Plug/Socket Connectors	T-Joints	
		Y-Joints	
5. Sensor Connector Assemblies Used to enable using connectors in sensors.	XS2M Plugs	Embedded Plugs with Screw Threads	
		Embedded Plugs with No Screw Threads	
6. Panel-mounting Connectors Used to enable using I/O box connectors mounted to panels.	XS2M Plugs	Flange-mounting Plugs	
		Screw-mounting Plugs	

XS2W Sockets and Plugs on Cable Ends

Model Number Legend

Use this model number legend to identify products from their model number. When ordering, use a model number from the table in *Ordering Information*.

XS2W-D **2** - **1** -

1
2
3
4
5
6
7
8
9

1. Type

W: Connectors connected to cable, socket and plug on cable ends

2. AC/DC (Mating Section Form)

D: For DC

3. Connector Poles

4: 4 poles

5: 5 poles

4. Contact Plating

2: 0.4- μ m gold plating

5. Cable Connection Direction

1: Straight/straight

2: L-shaped/L-shaped

3: Straight (Socket)/L-shaped (Plug)

4: L-shaped (Socket)/straight (Plug)

6. Cable Length

A: 0.3 m (straight/straight only)

B: 0.5 m (straight/straight only)

C: 1 m (straight/straight only)

D: 2 m

E: 3 m (straight/straight only)

F: 4 m (straight/straight only)

G: 5 m

H: 7 m (straight/straight only)

J: 10 m (straight/straight only)

K: 15 m (straight/straight only)

L: 20 m (straight/straight only)

7. Connections

Pin No.

① ② ③ ④

8: Brown White Blue Black (for DC)

Terminal No.

① ② ③ ④ ⑤

G: Brown White Blue Black Gray

8. Connectors on One End/Both Ends

1: Both ends

9. Cable Specifications

F: Fire-retardant, Robot cable

SA: Spatter-resistant Cable

XS2W Sockets and Plugs on Cable Ends

- Connectors with Fire-retardant, Robot cable
- Spatter-resistant Cable

XS2W-D42□-□81-F

XS2W-D421-□81-SA

Dimensions

(Unit: mm)

Straight/Straight Connectors

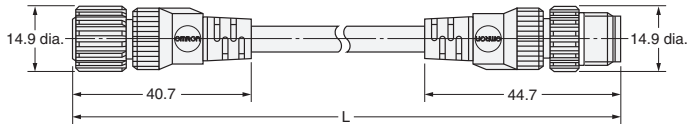

L-shaped/L-shaped Connectors

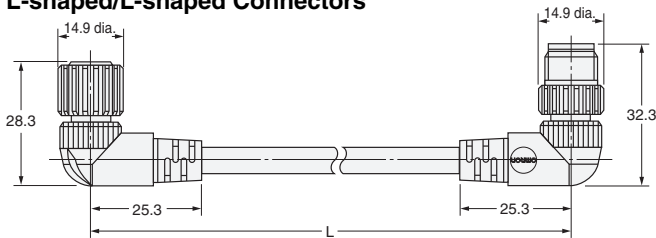

Straight/L-shaped Connectors

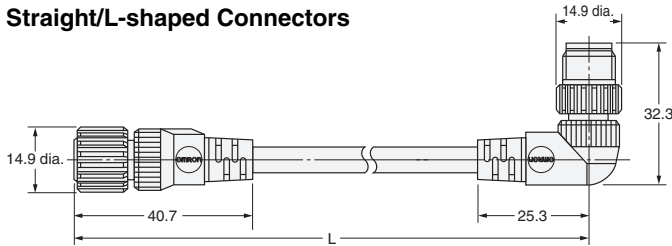

L-shaped/Straight Connectors

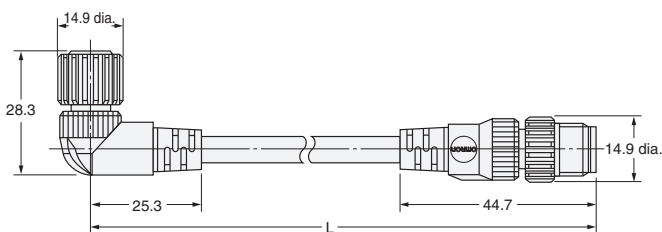

Wiring Diagram for 4 Cores

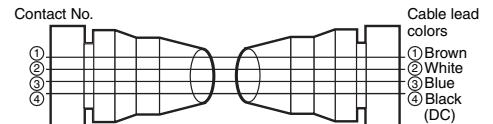

Wiring Diagram for 5 Cores

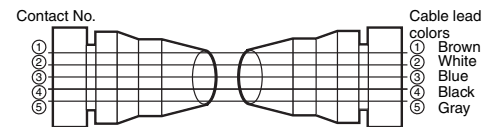

Ordering Information

Cable Specifications	Cable connection direction	Cable diameter (mm)	No. of cable cores	Cable core cross-sectional area (mm ²)	Cable length (m)	DC		UL -listed		
						Model	Minimum order			
Fire-retardant, Robot cable	Straight/Straight	6.0 mm dia.	4	0.5	1	XS2W-D421-C81-F	10	Yes		
					2	XS2W-D421-D81-F	5			
					5	XS2W-D421-G81-F	1			
					10	XS2W-D421-J81-F	1			
	L-shaped/L-shaped				Straight (Socket)/L-shaped (Plug)	2	XS2W-D422-D81-F		5	Yes
						5	XS2W-D422-G81-F			
						2	XS2W-D423-D81-F			
						5	XS2W-D423-G81-F			
L-shaped (Socket)/Straight (Plug)	2	XS2W-D424-D81-F	5	Yes						
	5	XS2W-D424-G81-F								
	2	XS2W-D424-D81-F								
Spatter-resistant Cables	Straight/Straight	6.6 mm dia.				2	XS2W-D421-D81-SA	5	---	
						5	XS2W-D421-G81-SA			

Note: Ask your OMRON representative about other cable lengths, and about 5-core cables.

XS2F Socket on One Cable End

Model Number Legend

Use this model number legend to identify products from their model number. When ordering, use a model number from the table in *Ordering Information*.

XS2F- **2** **-** **0-**

1
2
3
4
5
6
7
8
9

1. Type

F: Connector connected to cable, socket on one cable end

2. AC/DC (Mating Section Form)

A: For AC
 D: For DC
 E: For DC, stainless steel lock

3. Connector Poles

4: 4 poles
 5: 5 poles

4. Contact Plating

2: 0.4-µm gold plating

5. Cable Connection Direction

1: Straight
 2: L-shaped

6. Cable Length

A: 0.3 m
 B: 0.5 m
 C: 1 m
 D: 2 m
 E: 3 m
 F: 4 m
 G: 5 m
 H: 7 m
 J: 10 m
 K: 15 m
 L: 20 m

Only the 2 m (D), 5 m (G) and 10 m (J) cables are available for cables with 5 poles.

7. Connections

Terminal No.			
①	②	③	④
A: Brown	---	---	Blue (for DC)
B: ---	---	Brown	Blue (for DC)
C: Brown	---	Blue	Black
D: ---	---	Blue	Brown
8: Brown	White	Blue	Black (for DC)
9: Brown	White	Blue	Black (for AC)

8. Connectors on One End/Both Ends

0: One end

9. Cable Specifications

F: Standard cable (Fire-retardant, Robot cable)
 E: Heat-resistant cable up to 105°C
 SA: Spatter-resistant Cable
 E type and SA type is a 4-core cable.

Designations for DC Polarity (For Limit Switches and Sensors)

6. Cable Length

3: 2 m
 4: 5 m

7. Connections

Pin No.			
①	②	③	④
1: ---	---	Black	White

8. Connectors on One End/Both Ends

0: One end

9. Cable Specifications

Not designated.

Note: Model number standards are different for items 6, 7, and 9 for non-polar connectors.

Terminal No.				
①	②	③	④	⑤
G: Brown	White	Blue	Black	Gray

XS2F Sockets on One Cable End

- Connectors with Fire-retardant, Robot Cable XS2F-□42□-□□0-F
- Non-polar DC Connectors with Standard Cable XS2F-□42□-□□0
- E2E models with conventional connector pin with Fire-retardant, Robot Cable XS2F-D42□-□D0
- Heat-resistant Cable up to 105°C XS2F-E42□-□80-E
- Spatter-resistant Cables XS2F-D421-□80-SA

Dimensions

(Unit: mm)

Straight Connectors

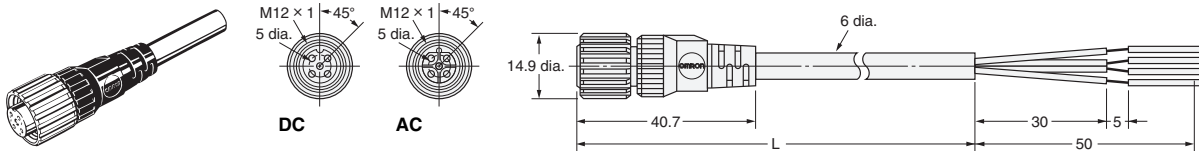

L-shaped Connectors

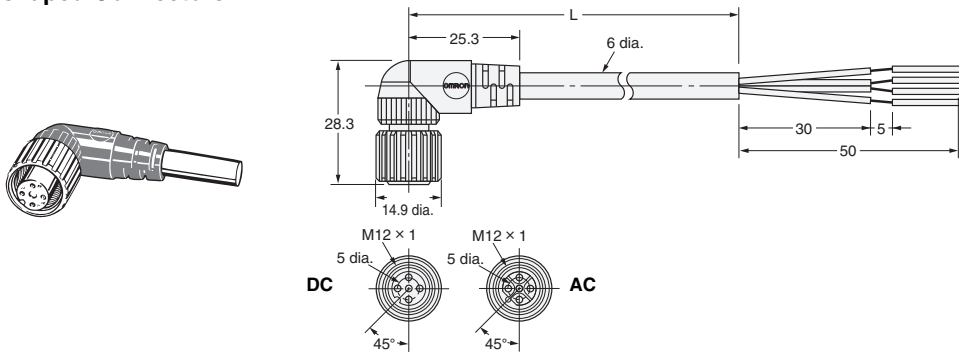

Wiring Diagram

		Two-core model	Three-core model	Four-core model
Fire-retardant, Robot cable	XS2F-□42□-□□0-F			
Spatter-resistant Cables*	XS2F-D421-□80-SA			
Heat-resistant Cables up to 105°C*	XS2F-E42□-□80-E			
Standard cable (non-polar DC)	XS2F-□42□-□□0		---	---
Fire-retardant, Robot cable (E2E models with conventional connector pin)	XS2F-D42□-□D0		---	---

*Spatter-resistant Cables and Heat-resistant Cables (105°C) are available only for four cores and DC.

Ordering Information

Cable Specifications	Cable connection direction	No. of cable cores	Cable outer diameter (mm)	Cable core cross-sectional area (mm ²)	Cable length (m)	DC	AC	Minimum order	UL-listed
						Model	Model		
Fire-retardant, Robot cable	Straight	2	6.0 mm dia.	0.5	1	XS2F-D421-CA0-F	XS2F-A421-CB0-F	10	Yes
		3				XS2F-D421-CC0-F	---		
		4				XS2F-D421-C80-F	XS2F-A421-C90-F		
		2			2	XS2F-D421-DA0-F	XS2F-A421-DB0-F	5	
		3				XS2F-D421-DC0-F	---		
		4				XS2F-D421-D80-F	XS2F-A421-D90-F		
		2			5	XS2F-D421-GA0-F	XS2F-A421-GB0-F	5	
		3				XS2F-D421-GC0-F	---		
		4				XS2F-D421-G80-F	XS2F-A421-G90-F		
		2			10	XS2F-D421-JA0-F	XS2F-A421-JB0-F	1	
	3	XS2F-D421-JC0-F				---			
	4	XS2F-D421-J80-F				XS2F-A421-J90-F			
	L-shaped	1			2	XS2F-D422-CA0-F	XS2F-A422-CB0-F	10	
					3	XS2F-D422-CC0-F	---		
					4	XS2F-D422-C80-F	---		
					2	XS2F-D422-DA0-F	XS2F-A422-DB0-F		
		2			3	XS2F-D422-DC0-F	---	5	
					4	XS2F-D422-D80-F	---		
					2	XS2F-D422-GA0-F	XS2F-A422-GB0-F		
		5			3	XS2F-D422-GC0-F	---	5	
4			XS2F-D422-G80-F	---					
2			XS2F-D422-JA0-F	XS2F-A422-JB0-F					
10	3	XS2F-D422-JC0-F	---	1					
	4	XS2F-D422-J80-F	---						
	2	XS2F-D421-310	XS2F-A421-310		5				
Standard cable (non-polar)	Straight	2	5	XS2F-D421-410		XS2F-A421-410	---		
		2	2	XS2F-D422-310		XS2F-A422-310			
Fire-retardant, Robot cable (E2E models with conventional connector pin)	Straight	2	2	XS2F-D421-DD0		---	5	---	
		2	5	XS2F-D421-GD0		---			
	L-shaped	2	2	XS2F-D422-DD0	---				
		2	5	XS2F-D422-GD0	---				
Heat-resistant cable up to 105°C *	Straight	4	2	2	XS2F-E421-D80-E	---	---		
			5	5	XS2F-E421-G80-E	---			
	L-shaped		2	2	XS2F-E422-D80-E	---			
			5	5	XS2F-E422-G80-E	---			
Spatter-resistant Cables	Straight/ Straight	4	6.6 mm dia.	2	2	XS2F-D421-D80-SA	---	---	
				5	5	XS2F-D421-G80-SA	---		

Note: Ask your OMRON representative about other cable lengths.
 *The heat-resistant fixture material is SUS316L stainless steel without surface treatment.

Applicable Proximity Sensors

Refer to page the *E2E Datasheet* for information on connecting to E2E Proximity Sensors

● 5-pole Connectors for DC XS2F-D521-□G0-A

Dimensions

(Unit: mm)

Straight Connectors

Note: Use the XS2H-D521-□G0-A in combination with the XS2F-D521-□G0-A.

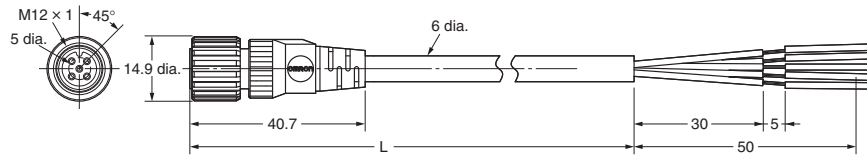
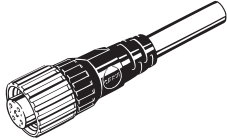

Wiring Diagram

Pin Arrangements (Engagement Side)

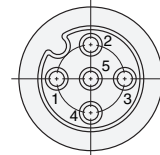
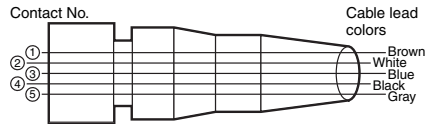

Ordering Information

No. of cable cores	Cable core cross-sectional area (mm ²)	Cable length (m)	DC	
			Model	Minimum order
5	0.3	2	XS2F-D521-DG0-A	5
		5	XS2F-D521-GG0-A	5
		10	XS2F-D521-JG0-A	5

Note: Ask your OMRON representative about other cable lengths.

XS2F Sockets on One Cable End with Indicator

Model Number Legend

XS2F-M12 PVC **A** **M** **LED**

1 2 3 4 5 6 7 8

1. Type

F: Connector connected to cable, sockets on one cable end

2. Mating Section Form

M12: M12

3. Cable material

PVC: PVC

4. Connector Poles

3: 3 poles
4: 4 poles

5. Cable Connection Direction

A: L-shaped

6. Cable Length

2: 2 m
5: 5 m
10: 10 m

7. Applicable Sensors

P: PNP
N: NPN

8. With indicator

LED: With indicator

Dimensions

(Unit: mm)

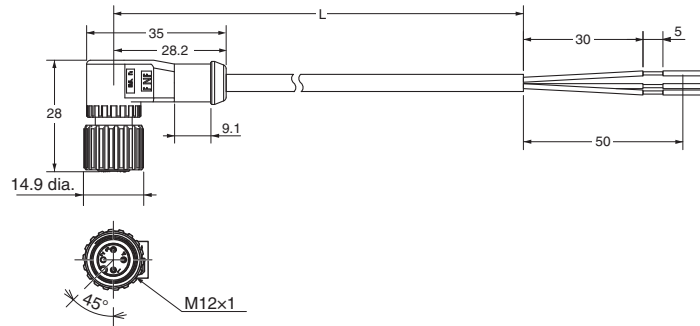
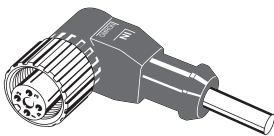

Wiring Diagram

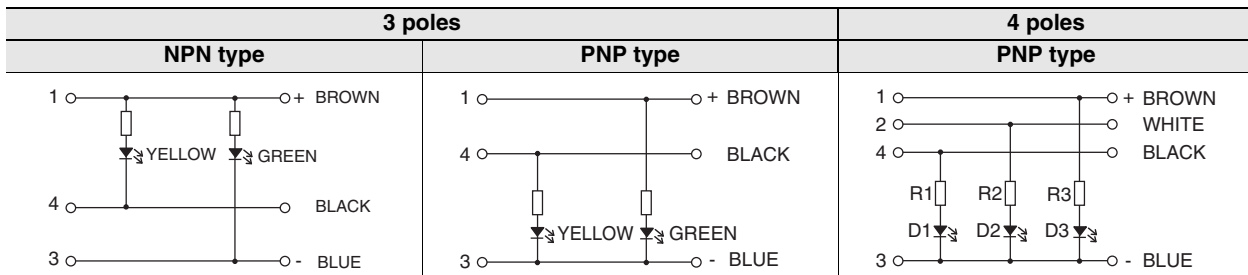

Ordering Information

Cable Specifications	Cable connection direction	Cable outer diameter (mm)	No. of cable cores	Cable core cross-sectional area (mm ²)	Cable length (m)	LED	Model	Minimum order	UL-listed
PVC	L-shaped	5 mm dia.	3	0.34	2	PNP	XS2F-M12PVC3A2MPLED	1	Yes
					5		XS2F-M12PVC3A5MPLED		
					10		XS2F-M12PVC3A10MPLED		
					2	NPN	XS2F-M12PVC3A2MNLED		
					5		XS2F-M12PVC3A5MNLED		
					10		XS2F-M12PVC3A10MNLED		
		5.4 mm dia.	4		2	PNP	XS2F-M12PVC4A2MPLED		
					5		XS2F-M12PVC4A5MPLED		
					10		XS2F-M12PVC4A10MPLED		

XS2H Plugs on One Cable End

Model Number Legend

XS2H-□□21-□□0-□□

1
2
3
4
5
6
7
8
9

1. Type

H: Connector connected to cable, plug on one cable end

2. AC/DC

A: For AC

D: For DC

3. Connector Poles

4: 4 poles

5: 5 poles

Using this model number legend to identify products from their model number. When ordering, use a model number from the table in *Ordering Information*.

4. Contact Plating

2: 0.4-μm gold plating

5. Cable Connection Direction

1: Straight

6. Cable Length

A: 0.3 m

B: 0.5 m

C: 1 m

D: 2 m

G: 5 m

7. Connections

Terminal No.

① ② ③ ④

8: Brown White Blue Black (for DC)

9: Brown White Blue Black (for AC)

Terminal No.

① ② ③ ④

A: Brown --- --- Blue (for DC)

B: --- --- Brown Blue (for AC)

C: Brown --- Blue Black (for DC)

Terminal No.

① ② ③ ④ ⑤

G: Brown White Blue Black Gray

8. Connectors on One End/Both Ends

0: One end

9. Cable Specifications

A: Standard cable

F: Fire-retardant, Robot cable

SA: Spatter-resistant Cable

XS2H Plugs on One Cable End

- Connectors with Fire-retardant, Robot Cable XS2H-□421-□□0-F
- Spatter-resistant Cable XS2H-D421-□80-SA

Dimensions

(Unit: mm)

Straight Connectors

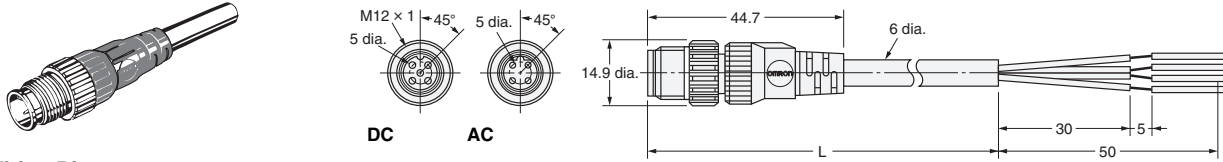

Wiring Diagram

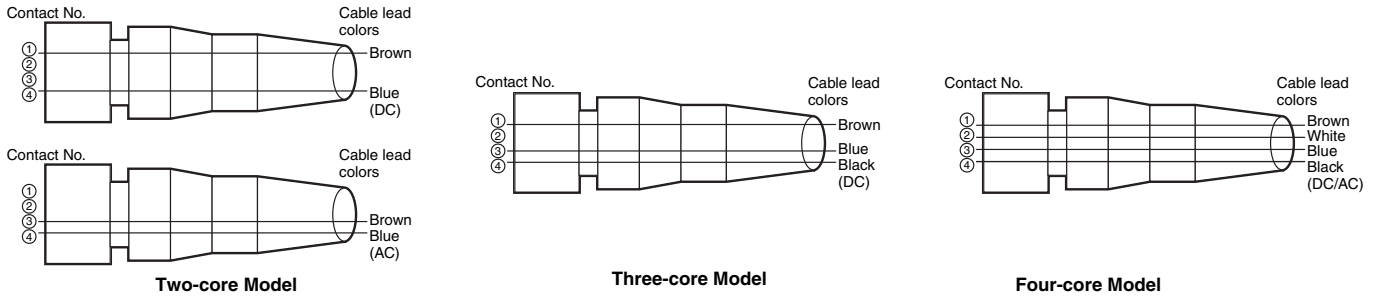

● Connectors on DC Cable (Five Poles) XS2H-D521-□G0-A (for DC)

Dimensions

(Unit: mm)

Straight Connectors

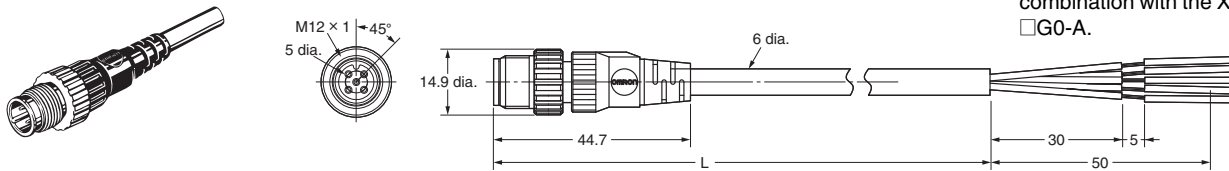

Wiring diagram

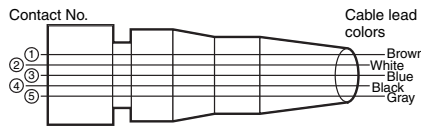

Pin Arrangements (Engagement Side)

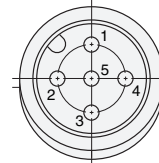

Ordering Information

Cable Specifications	No. of connector poles	Cable connection direction	No. of cable cores	Cable outer diameter (mm)	Cable core cross-sectional area (mm ²)	Cable length (m)	DC	AC	Minimum order	UL-listed
							Model	Model		
Fire-retardant, Robot cable	4	Straight	2	6.0 mm dia.	0.5	0.3	XS2H-D421-AA0-F	XS2H-A421-AB0-F	10	Yes
			3				---			
			4				---			
			2				XS2H-A421-A90-F			
			3				XS2H-D421-CA0-F	XS2H-A421-CB0-F		
			4				XS2H-D421-CC0-F	---		
Spatter-resistant Cables	4	Straight	4	6.6 mm dia.	0.3	0.3	XS2H-D421-C80-F	XS2H-A421-C90-F	10	---
						1	XS2H-D421-A80-SA	---		
						1	XS2H-D421-C80-SA	---		
Standard cable	5	Straight	5	6.0 mm dia.	0.3	0.3	XS2H-D521-AG0-A	---	10	---
						1	XS2H-D521-CG0-A	---		

XS2 Sensor I/O Connectors on Cables (8-pole)

Ordering Information

Connector type	Cable connection direction	Applicable wire diameter	Number of cores	Cable length (m)	Model
Panel-mounting socket	---	AWG22 to 28	---	---	XS2P-D821-2
Panel-mounting plug					XS2P-D822-2
Plug on one cable end	Straight	---	8	0.3	XS2H-D821-AH0-C
Socket on one cable end				1	XS2H-D821-CH0-C
				2	XS2F-D821-DH0-C
				5	XS2F-D821-GH0-C
				2	XS2W-D821-DH1-C
Plug and socket on cable ends				5	XS2W-D821-GH1-C

Pin Numbers and Cable Lead Colors

XS2F/XS2H/XS2W cable lead colors	Pin number							
	1	2	3	4	5	6	7	8
	White	Brown	Green	Yellow	Gray	Pink	Blue	Shield

Ratings and Characteristics

Rated current	1.5 A
Rated voltage	36 VDC
Contact resistance	40 MΩ max. (at 20 mVDC max. and 100 mA max.)
Insulation resistance	1,000 MΩ min. (at 500 VDC)
Dielectric strength	1,000 VAC for 1 min (leakage current: 1 mA max.)
Degree of protection	IP67
Insertion durability	200 times min.
Operating temperature	-25 to 70°C

Materials and Finish

Contacts	Brass/nickel base, 0.4-μm goldplating
Bracket, body, M16 nuts	Brass/nickel plated
Pin block	PBT resin (UL94V-0)/light gray
Cover *1	PBT resin (UL94V-0)
Seal rubber and O-ring *2	Rubber
Cable	Standard Cable (8 core) 6 mm dia. AWG24 (0.25 mm ²) Structure: 0.127 mm/20 wires

*1. XS2F/XS2H/XS2W only.

*2. O-rings are on sockets only.

Wiring Example

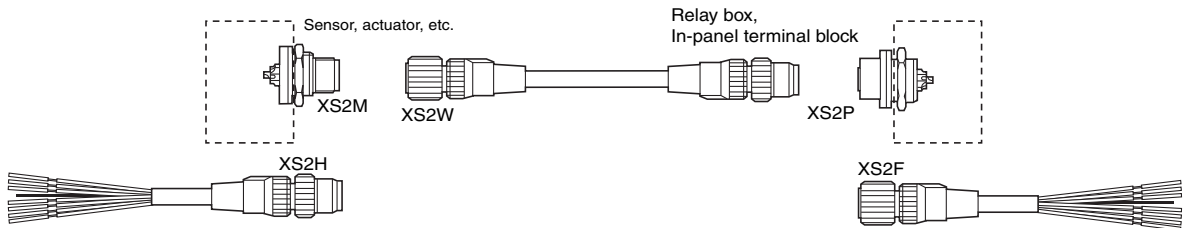

Dimensions

XS2H Plug on One Cable End (M12)

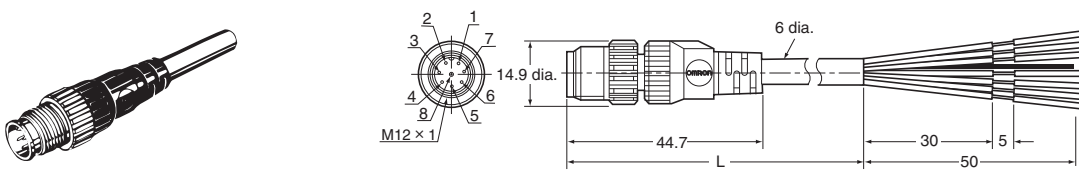

XS2F Socket on One Cable End (M12)

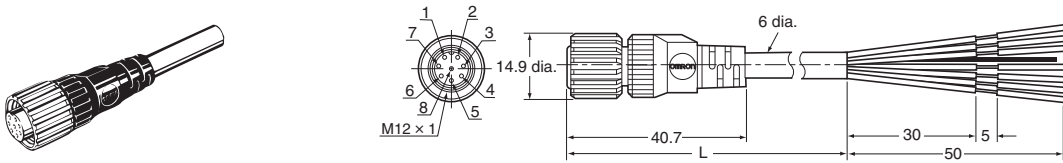

XS2W Plug and Socket on Cable Ends (M12)

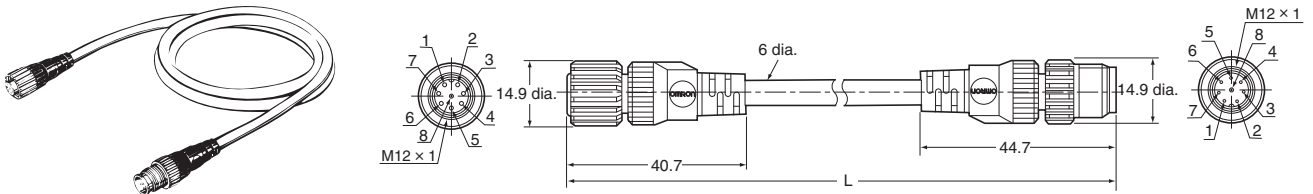

XS2P-D821-2 Panel-mounting Socket (M12) with Solder Cup Pins and Rear Lock

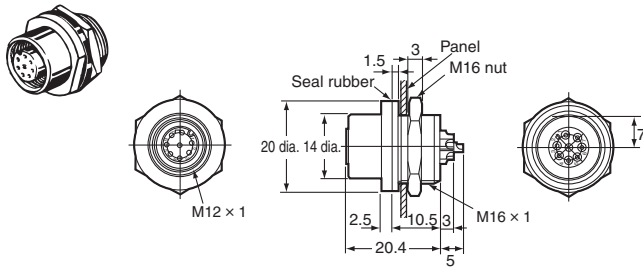

XS2M-D824-4 Panel-mounting Plug (M12) with Solder Cup Pins and Front Lock

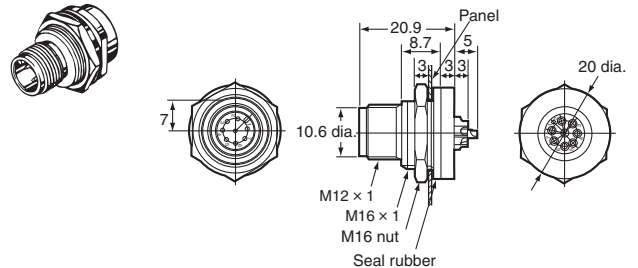

XS2P-D822-2 Panel-mounting Socket (M12) with Solder Cup Pins and Front Lock

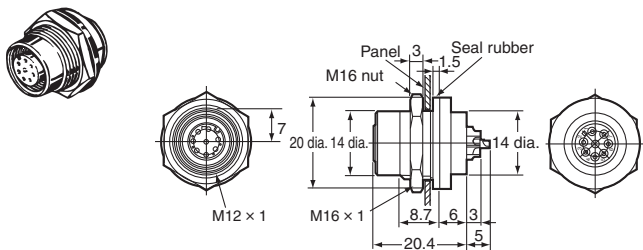

Panel Cutouts

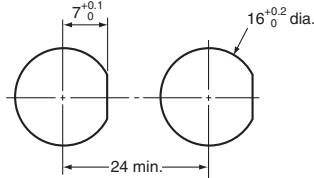

Connector Pin Numbers (from Mating Side)

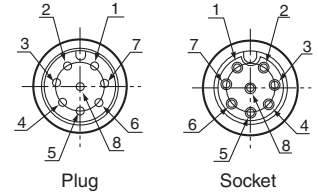

- Note 1. Mounting panel thickness: 1 to 4 mm.
- 2. Applicable core wire size for solder cup pins: 0.5 mm² max.
- 3. The M16 nut and seal rubber are included.

XS2G Crimping/Soldering Plug Assemblies

Dimensions

(Unit: mm)

XS2G-□4C□ (Crimping Model)
 XS2G-□42□ (Soldering Model)
 Straight Connectors

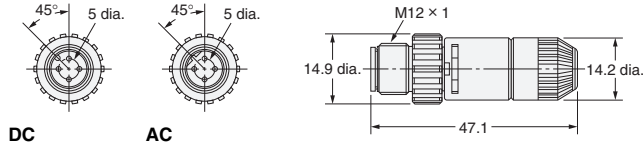
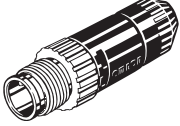

XS2G-D42□ (Soldering Model)
 L-shaped Connectors

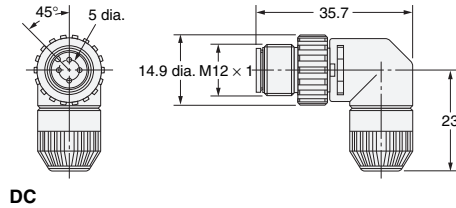
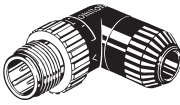

Ordering Information

Suitable cable dia. (mm)	Suitable core size (mm ²)	Suitable Sheath material	Cable connection direction	Connection method	DC	AC	Minimum order
					Model	Model	
6 mm dia. model (5 to 6 mm dia.)	0.18 to 0.3 0.5 to 0.75 *	PVC, PE, PUR	Straight	Crimping	XS2G-D4C1	XS2G-A4C1	50
	Soldering			XS2G-D421	XS2G-A421		
4 mm dia. model (4 to 5 mm dia.)	0.18 to 0.3 0.5 to 0.75 *		Straight	Crimping	XS2G-D4C3	XS2G-A4C3	
	0.5 max.			Soldering	XS2G-D423	XS2G-A423	
3 mm dia. model (3 to 4 mm dia.)	0.18 to 0.3 0.5 to 0.75 *		Straight	Crimping	XS2G-D4C5	XS2G-A4C5	
	0.5 max.			Soldering	XS2G-D425	XS2G-A425	
		L-shaped	Soldering	XS2G-D422	---		
		L-shaped	Soldering	XS2G-D424	---		
		L-shaped	Soldering	XS2G-D426	---		

*There are two types of contacts.
 Note: Crimping plug contacts are sold separately.
 Use a cable of mentioning. When not using a cable of mentioning, there is a possibility that the performance can't be met.
 Ask your OMRON representative about selecting a cable of other than above.

XS2U Crimping Pin for XS2G

Dimensions

(Unit: mm)

XS2U-312□ (Plug Pin)

Note: A special tool must be used for crimping. For details, refer to page 24.

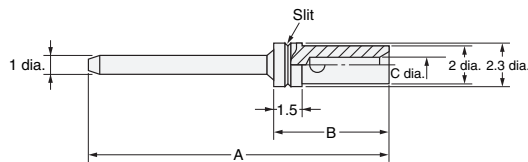
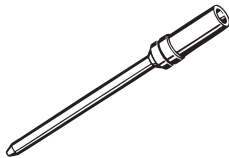

Dimensions

Model	Suitable core size (mm ²)	Dimension (mm)			No. of slits
		A	B	C	
XS2U-3121	0.18 to 0.3	20.0	6.1	0.8	1
XS2U-3122	0.5 to 0.75	20.1	6.2	1.3	0

Ordering Information

Suitable core size (mm ²)	Model	Minimum order
0.18 to 0.3	XS2U-3121	100
0.5 to 0.75	XS2U-3122	

Note: Orders are accepted in multiples of the minimum order.

XS2C Crimping/Soldering Socket Assemblies

Dimensions

(Unit: mm)

XS2C-□4C□ (Crimping Model)
XS2C-□42□ (Soldering Model)
Straight Connectors

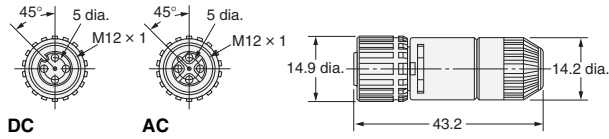
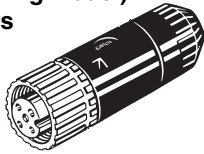

L-shaped Connectors

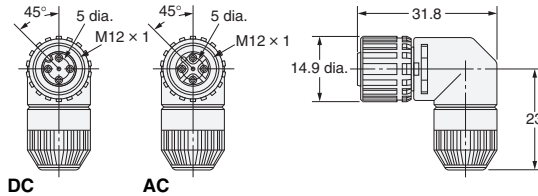
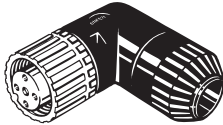

Ordering Information

Suitable cable dia. (mm)	Suitable core size (mm ²)	Suitable Sheath material	Cable connection direction	Connection method	DC	AC	Minimum order
					Model	Model	
6 mm dia. model (5 to 6 mm dia.)	0.18 to 0.3 0.5 to 0.75 *	PVC, PE, PUR	Straight	Crimping	XS2C-D4C1	XS2C-A4C1	50
				Soldering	XS2C-D421	XS2C-A421	
	0.5 max.		L-shaped	Crimping	XS2C-D4C2	XS2C-A4C2	
				Soldering	XS2C-D422	XS2C-A422	
4 mm dia. model (4 to 5 mm dia.)	0.18 to 0.3 0.5 to 0.75 *		Straight	Crimping	XS2C-D4C3	XS2C-A4C3	
				Soldering	XS2C-D423	XS2C-A423	
	0.5 max.		L-shaped	Crimping	XS2C-D4C4	XS2C-A4C4	
				Soldering	XS2C-D424	XS2C-A424	
3 mm dia. model (3 to 4 mm dia.)	0.18 to 0.3 0.5 to 0.75 *	Straight	Crimping	XS2C-D4C5	XS2C-A4C5		
			Soldering	XS2C-D425	XS2C-A425		
	0.5 max.	L-shaped	Crimping	XS2C-D4C6	XS2C-A4C6		
			Soldering	XS2C-D426	XS2C-A426		

*There are two types of contacts.

Note: Crimping plug contacts are sold separately.

Use a cable of mentioning. When not using a cable of mentioning, there is a possibility that the performance can't be met. Ask your OMRON representative about selecting a cable of other than above.

XS2U Crimping Pin for XS2C

Dimensions

(Unit: mm)

XS2U-222□ (Socket Pin)

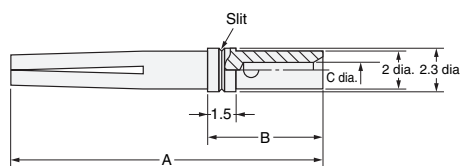

Note: A special tool must be used for crimping. For details, refer to page 24.

Dimensions

Model	Suitable core size (mm ²)	Dimension (mm)			No. of slits
		A	B	C	
XS2U-2221	0.18 to 0.3	16.7	6.1	0.8	1
XS2U-2222	0.5 to 0.75	16.8	6.2	1.3	0

Ordering Information

Suitable core size (mm ²)	Model	Minimum order
0.18 to 0.3	XS2U-2221	100
0.5 to 0.75	XS2U-2222	

Note: Orders are accepted in multiples of the minimum order.

XS2G Screw-on Plug Assemblies

Dimensions

(Unit: mm)

- XS2G-D5S7 (5-pole, Straight, Applicable Cable Outer Diameter: 8 mm)
- XS2G-D5S9 (5-pole, Straight, Applicable Cable Outer Diameter: 7 mm)
- XS2G-D4S7 (4-pole, Straight, Applicable Cable Outer Diameter: 8 mm)
- XS2G-D4S9 (4-pole, Straight, Applicable Cable Outer Diameter: 7 mm)

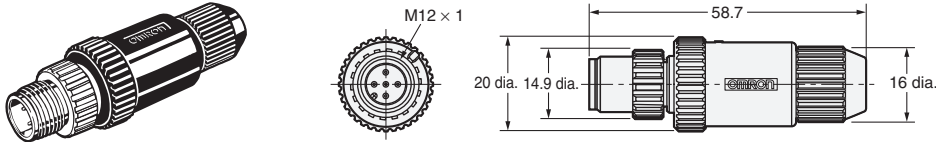

- XS2G-D5S1 (5-pole, Straight, Applicable Cable Outer Diameter: 6 mm)
- XS2G-D4S□ (4-pole, Straight, Applicable Cable Outer Diameter: 3, 4, or 6 mm)

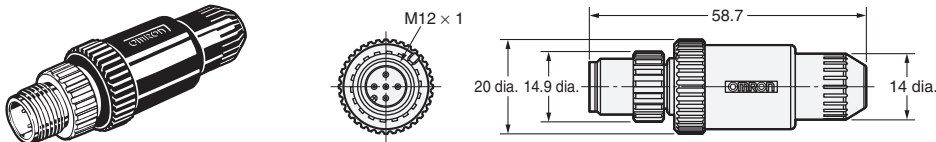

- XS2G-D5S2 (5-pole, L-shaped, Applicable Cable Outer Diameter: 6 mm)
- XS2G-D4S□ (4-pole, L-shaped, Applicable Cable Outer Diameter: 3, 4, or 6 mm)

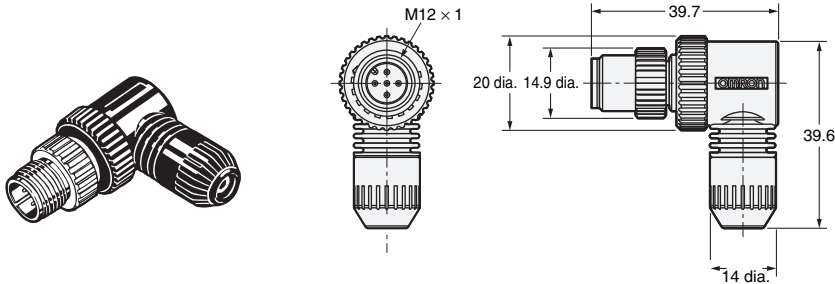

Ordering Information

No. of poles	Suitable cable dia. (mm)	Suitable core size (mm ²)	Suitable Sheath material	Straight connectors (for DC)	L-shaped connectors (for DC)	Minimum order
				Model	Model	
5	8 mm dia. model (7 to 8 mm dia.)	0.18 to 0.75	PVC, PE, PUR	XS2G-D5S7	---	50
	7 mm dia. model (6 to 7 mm dia.)			XS2G-D5S9	---	
	6 mm dia. model (5 to 6 mm dia.)			XS2G-D5S1	XS2G-D5S2	
4	8 mm dia. model (7 to 8 mm dia.)			XS2G-D4S7	---	
	7 mm dia. model (6 to 7 mm dia.)			XS2G-D4S9	---	
	6 mm dia. model (5 to 6 mm dia.)			XS2G-D4S1	XS2G-D4S2	
	4 mm dia. model (4 to 5 mm dia.)			XS2G-D4S3	XS2G-D4S4	
	3 mm dia. model (3 to 4 mm dia.)			XS2G-D4S5	XS2G-D4S6	

Note: XS2G Screw-on Plugs cannot be connected to side by side to the CN1 and CN2 connectors of XS2R Y-Joint Sockets/Plugs.
 Use a cable of mentioning. When not using a cable of mentioning, there is a possibility that the performance can't be met.
 Ask your OMRON representative about selecting a cable of other than above.

XS2C Screw-on Socket Assemblies

Dimensions

(Unit: mm)

- XS2C-D5S7 (5-pole, Straight, Applicable Cable Outer Diameter: 8 mm)
- XS2C-D5S9 (5-pole, Straight, Applicable Cable Outer Diameter: 7 mm)
- XS2C-D4S7 (4-pole, Straight, Applicable Cable Outer Diameter: 8 mm)
- XS2C-D4S9 (4-pole, Straight, Applicable Cable Outer Diameter: 7 mm)

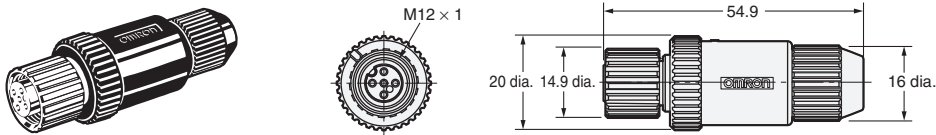

- XS2C-D5S1 (5-pole, Straight, Applicable Cable Outer Diameter: 6 mm)
- XS2C-D4S□ (4-pole, Straight, Applicable Cable Outer Diameter: 3, 4, or 6 mm)

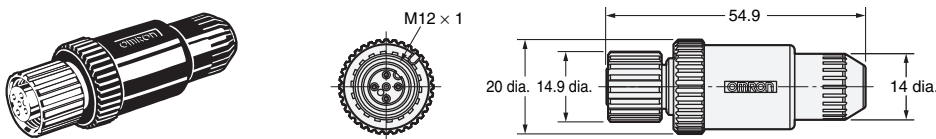

- XS2C-D5S2 (5-pole, L-shaped, Applicable Cable Outer Diameter: 6 mm)
- XS2C-D4S□ (4-pole, L-shaped, Applicable Cable Outer Diameter: 3, 4, or 6 mm)

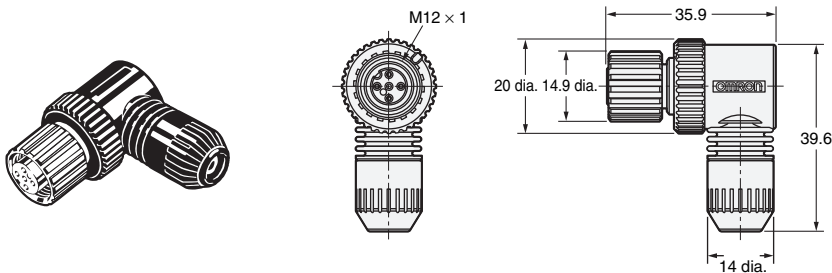

Ordering Information

No. of poles	Suitable cable dia. (mm)	Suitable core size (mm ²)	Suitable Sheath material	Straight connectors (for DC)	L-shaped connectors (for DC)	Minimum order
				Model	Model	
5	8 mm dia. model (7 to 8 mm dia.)	0.18 to 0.75	PVC, PE, PUR	XS2C-D5S7	---	50
	7 mm dia. model (6 to 7 mm dia.)			XS2C-D5S9	---	
	6 mm dia. model (5 to 6 mm dia.)			XS2C-D5S1	XS2C-D5S2	
4	8 mm dia. model (7 to 8 mm dia.)			XS2C-D4S7	---	
	7 mm dia. model (6 to 7 mm dia.)			XS2C-D4S9	---	
	6 mm dia. model (5 to 6 mm dia.)			XS2C-D4S1	XS2C-D4S2	
	4 mm dia. model (4 to 5 mm dia.)	XS2C-D4S3	XS2C-D4S4			
	3 mm dia. model (3 to 4 mm dia.)	XS2C-D4S5	XS2C-D4S6			

Note: Use a cable of mentioning. When not using a cable of mentioning, there is a possibility that the performance can't be met. Ask your OMRON representative about selecting a cable of other than above.

XS2P Panel-mounting Sockets for Terminal Boxes

Dimensions

(Unit: mm)

XS2P-□421-2 (with Solder Cup Pins) Rear Lock Model

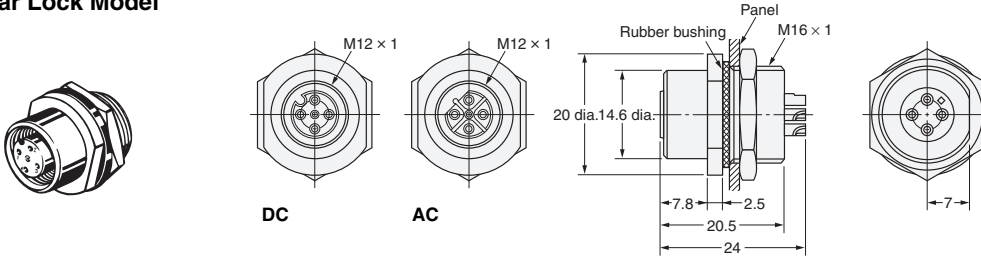

XS2P-□422-1 (with DIP Pins) XS2P-□422-2 (with Solder Cup Pins) Front Lock Model

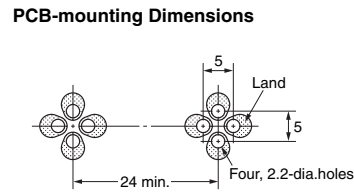
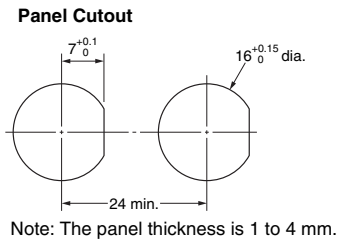
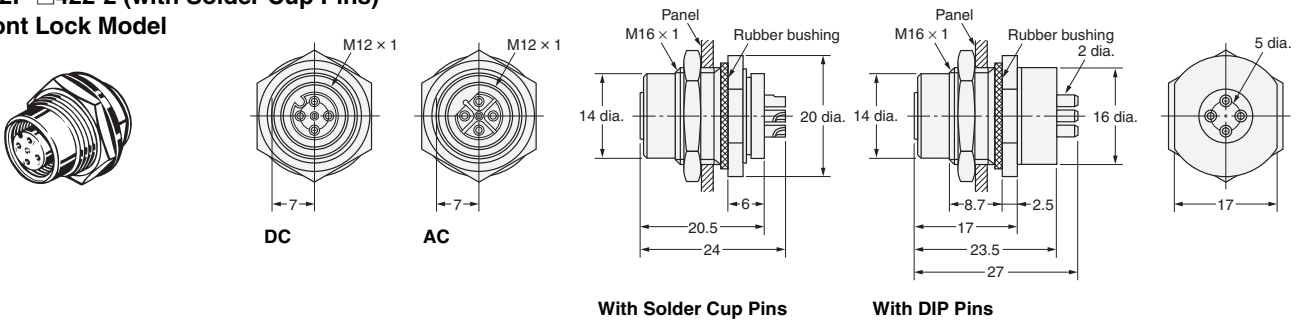

Ordering Information

Lock method	Pin shape	Applicable wire diameter	DC	AC	Minimum order
			Model	Model	
Rear lock	Solder cup pin	AWG20 to 28	XS2P-D421-2	XS2P-A421-2	50
	Solder cup pin		XS2P-D422-2	XS2P-A422-2	
Front lock	DIP pin		XS2P-D422-1	XS2P-A422-1	

XS2R Y-Joint Plug/Socket Connectors

Dimensions

(Unit: mm)

XS2R-D426-□11-F

Connectors on Both Cable Ends (Y-Joint Plug/Socket)

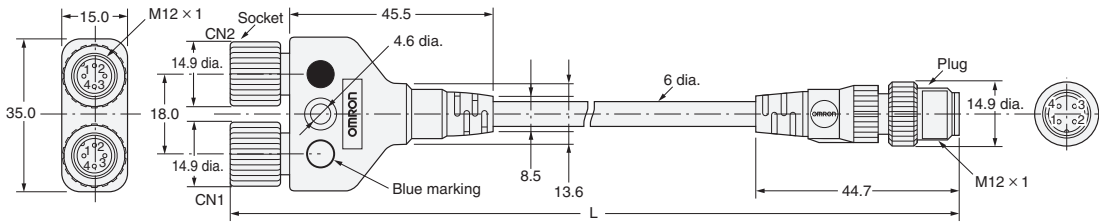

Wiring Diagram

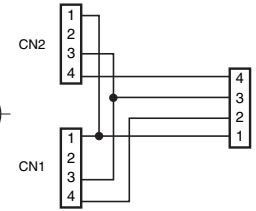

XS2R-D426-□10-F

Connectors on One Cable End (Y-Joint Plug/Socket)

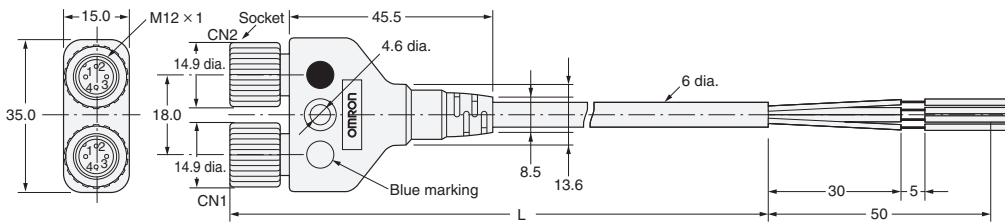

Wiring Diagram

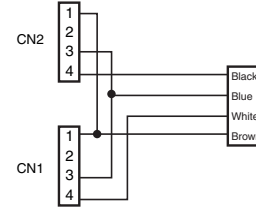

XS2R-D426-1

Y-Joint Plug/Socket without Cable

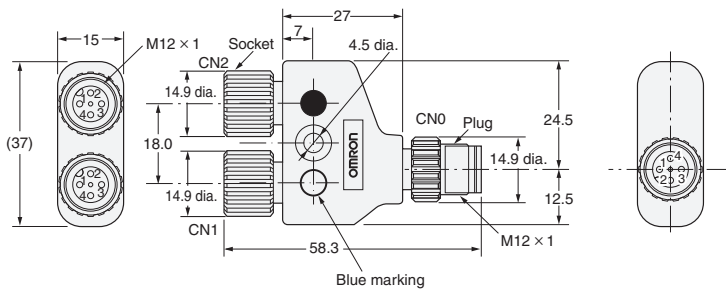

Wiring Diagram

XS2R-D426-1

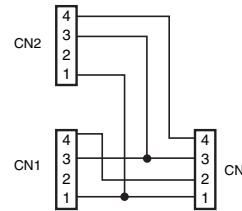

XS2R-D426-5

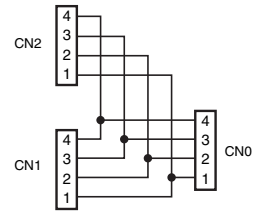

XS2R-D426-81

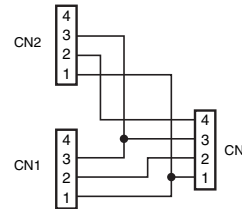

XS2R-D426-82

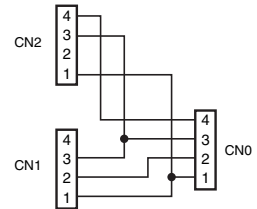

Ordering Information

Type	Connector	DC		
		Cable length L (m)	Model	Minimum order
With cable	Connectors on both cable ends	0.5	XS2R-D426-B11-F	5
		1	XS2R-D426-C11-F	
		2	XS2R-D426-D11-F	
		3	XS2R-D426-E11-F	
	Connector on one cable end	2	XS2R-D426-D10-F	
5		XS2R-D426-G10-F		
Without cable	Y-Joint plug/socket	---	XS2R-D426-1	10
		---	XS2R-D426-5	
		---	XS2R-D426-81	
		---	XS2R-D426-82	

Note: XS2G Screw-on Plugs cannot be connected side-by-side to the CN1 and CN2 connectors.
Consider using a crimping or soldering model instead. Refer to page 14 for details.

XS2R T-Joint Plug/Socket Connectors

Dimensions

(Unit: mm)

XS2R-D422-1
XS2R-D422-5
Aggregate Models

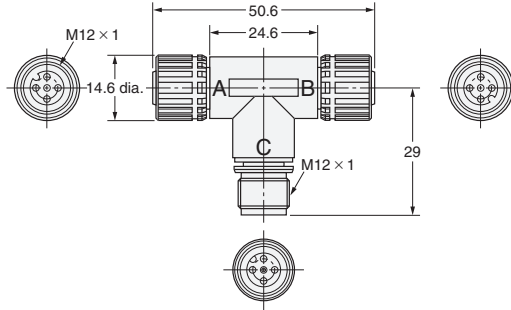
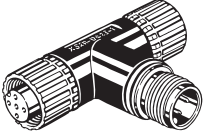

Wiring Diagram
XS2R-D422-1

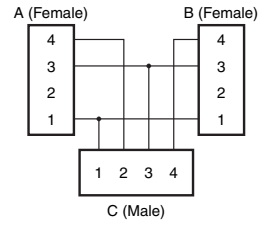

XS2R-D422-5

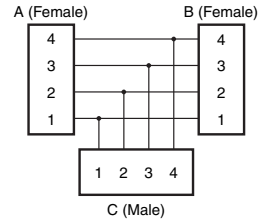

XS2R-D423-1
Bifurcated Model

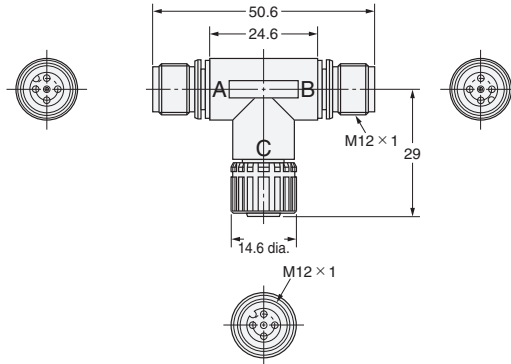
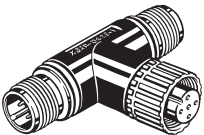

Wiring Diagram

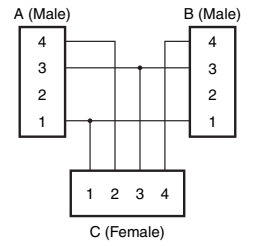

XS2R-D424-1
Daisy-chain Model

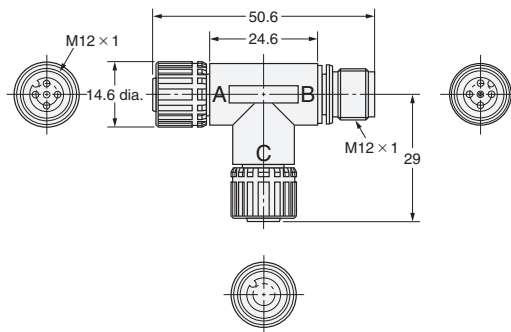
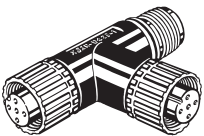

Wiring Diagram

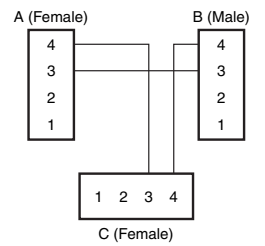

Ordering Information

Type	DC	
	Model	Minimum order
Aggregate model	XS2R-D422-1	20
	XS2R-D422-5	
Bifurcated model	XS2R-D423-1	
Daisy-chain model	XS2R-D424-1	

XS2R Application Examples

XS2R-D422-1 (Aggregate Model)

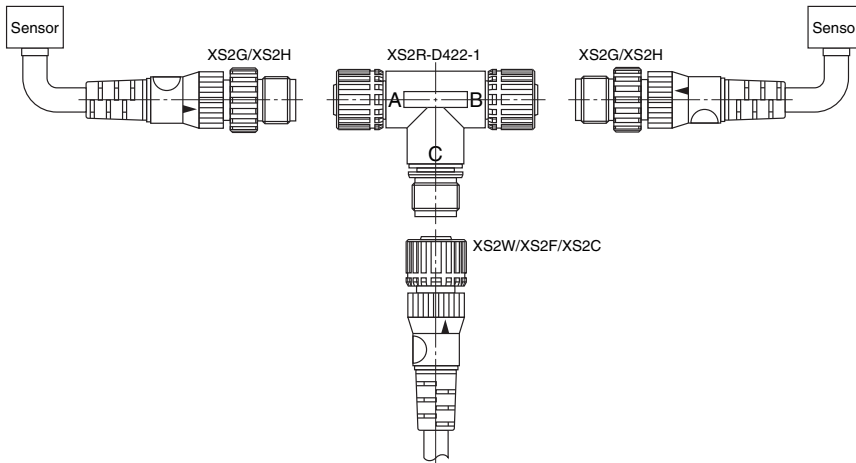

- A pair of Two-wire Sensors or Three-wire Sensors can be connected as shown in the illustration.
- The XS2R-D422-5 has feedthrough connections, thus working as a connector for the extension cable.

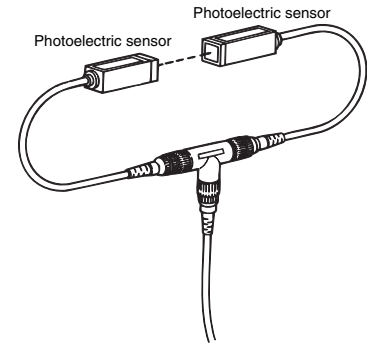

XS2R-D423-1 (Bifurcated Model)

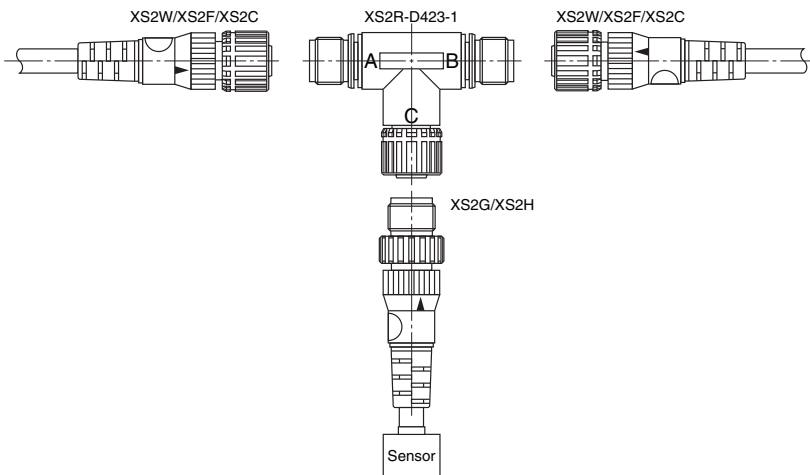

- Two or Three-wire Sensor signals can be bifurcated.

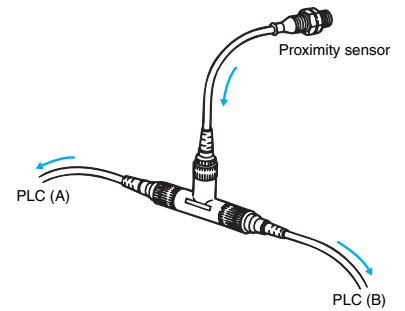

XS2R-D424-1 (Daisy Chain Model)

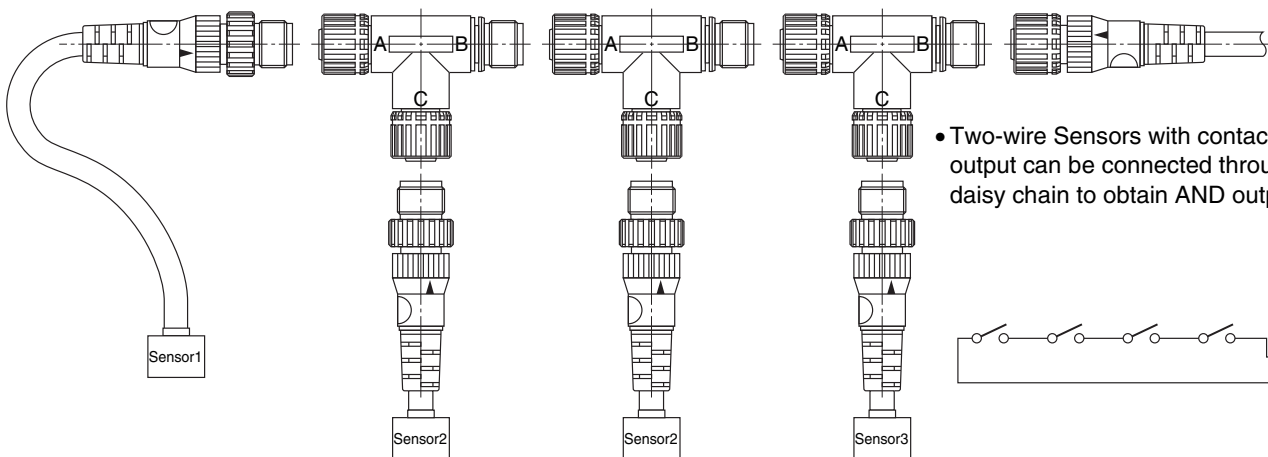

- Two-wire Sensors with contact output can be connected through a daisy chain to obtain AND output.

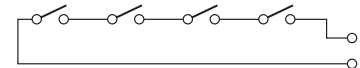

Safety Precautions

Precautions for Correct Use

Do not use this product under ambient conditions that exceed the ratings.

Before using the XS2R for Sensors, make sure that the wiring of the Sensors and the internal connections of the XS2R are correct.

XS2M Sensor-embedded Plugs

Dimensions

(Unit: mm)

XS2M-D421 (DC)
XS2M-A421 (AC)
 (Embedded Plug with Screw Threads)

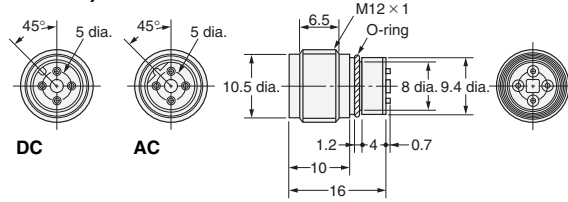

Mounted Dimensions

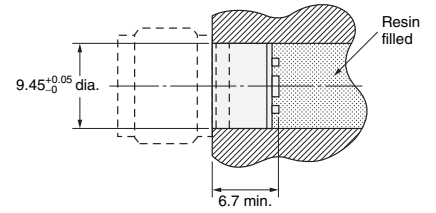

Note: After mounting, anchor the solder cups by injecting resin.

XS2M-D422 (DC)
XS2M-A422 (AC)
 (Embedded Plug without Screw Threads)

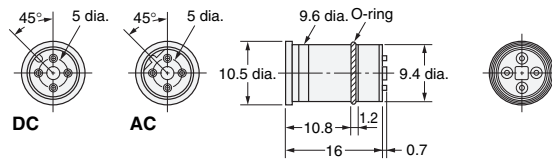

Mounted Dimensions

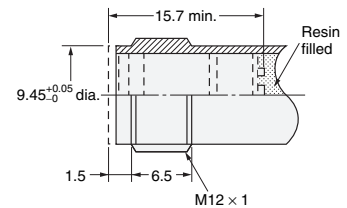

Note: After mounting, anchor the solder cups by injecting resin.

XS2M Panel-mounting Plugs

Dimensions

(Unit: mm)

XS2M-D423 (For DC)
XS2M-A423 (For AC)
 (Flange-mounting Model)

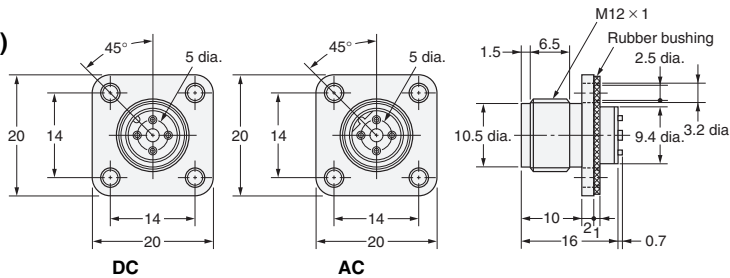

Panel Cutouts

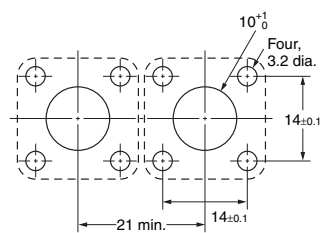

XS2M-□424-1 (With DIP Pins)
XS2M-□424-2 (With Solder Cup Pins)
 (Screw-mounting Model)

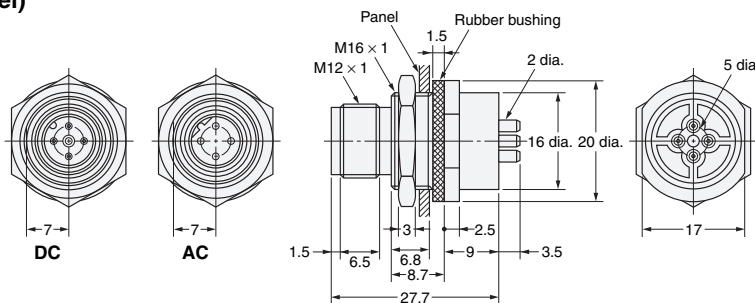
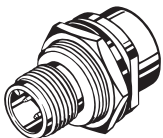

Panel Cutouts

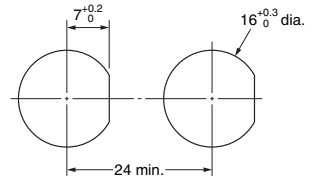

Note: The panel thickness is 1 to 4 mm.

PCB-mounting Dimensions

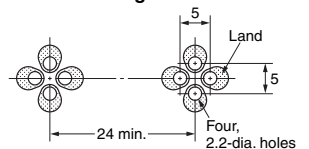

Ordering Information

Mounting method	Pin shape	Applicable wire diameter	DC	AC	Minimum order
			Model	Model	
Embedded with screw threads	Solder cup pin	AWG22 to 28	XS2M-D421	XS2M-A421	50
Embedded with no screw threads			XS2M-D422	XS2M-A422	
Flange-mounting			XS2M-D423	XS2M-A423	
Screw-mounting	DIP pin	---	XS2M-D424-1	XS2M-A424-1	
	Solder cup pin	AWG20 to 28	XS2M-D424-2	XS2M-A424-2	

Connector Covers

Water-resistant Covers

XS2Z-11

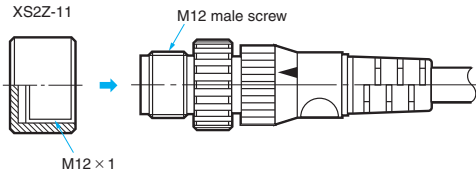

XS2Z-22

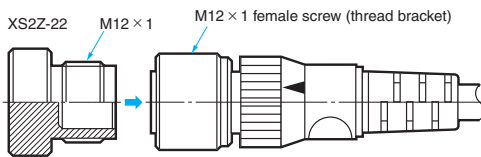

You can use the Water-resistant Cover when the connector is not connected to ensure an IP67 degree of protection. When mounting the Water-resistant Cover to a Connector, be sure to apply a torque range between 0.39 and 0.49 N·m to tighten the Water-resistant Cover.

Model	Minimum order	Material	Suitable connector	
			Model	Mounting portion
XS2Z-11	50	Brass/nickel plated	XS2G/XS2H/XS2M/XS2R/XS2W/XS5H/XS5M/XS5W	M12 male screw
XS2Z-22			XS2C/XS2R/XS2F/XS2P/XS2W/XW3B/XS5F/XS5W/XS5R/XS5P/XW3D	M12 female screw (thread bracket)

Dust Covers

XS2Z-13

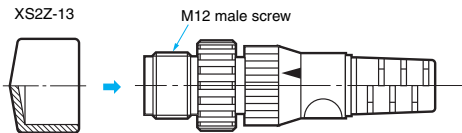

XS2Z-15/XS2Z-14

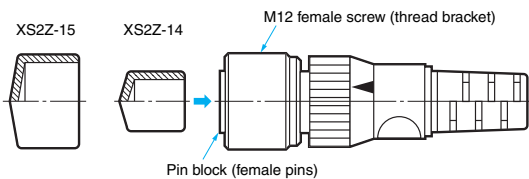

The Dust Cover is for dust prevention and does not ensure IP67 degree of protection. When mounting the Dust Cover to a connector, be sure to press the Dust Cover onto the Connector until the Connector is fully inserted into the Dust Cover.

Model	Minimum order	Material	Suitable connector	
			Model	Mounting portion
XS2Z-13	50	Rubber/black	XS2G/XS2H/XS2M/XS2R	M12 male screw
XS2Z-14			XS2C/XS2R/XS2F/XS2P/XW3A/XW3B	Pin block (female pins)
XS2Z-15				M12 female screw (thread bracket)

Loosening-preventing C Ring

XS2Z-18

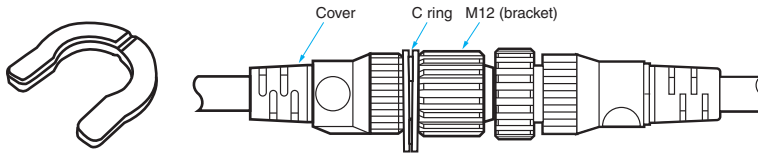

This C ring prevents the M12 connector from becoming loose. When you attach the C ring, press it securely between the bracket and cover.

Model	Material	Applicable connector
XS2Z-18	POM	XS2F/H/W

Sputter Protective Cover

XS2Z-31

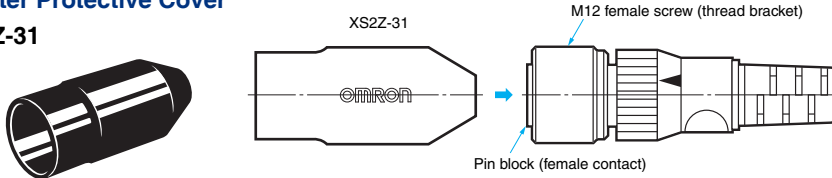

The Sputter Protective Cover protects the connector from weld sputter. Make sure it covers the entire connector.

Model	Material	Applicable connector
XS2Z-31	Silicone rubber/black	XS2F/XS2H/XS2W

Tools

Torque Wrench

XY2F-0004

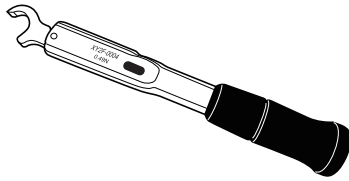

Crimp Tool

XY2F-0002

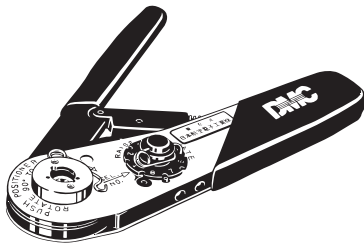

Use the Crimp Tool to crimp a cable core to the XS2U Crimping Pin used with the XS2C or XS2G Crimping Connector.

Locator

XY2F-0003

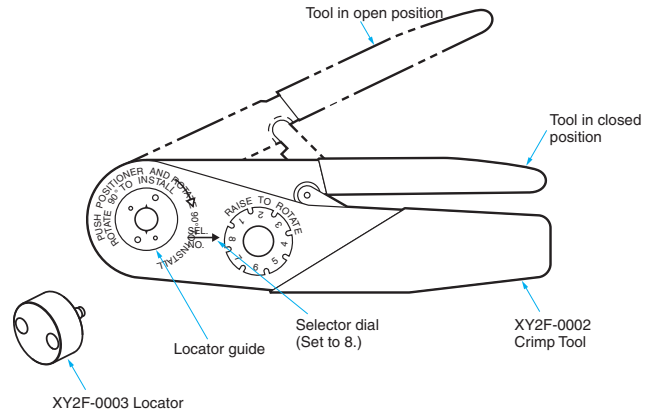

- The XY2F-0002 Crimp Tool is DMC's AFM8 (M22520/2-01).
- Mount the XY2F-0003 Locator (sold separately) to the locator guide of the Crimp Tool with a screw provided with the XY2F-0003 Locator.

Pin-block Extraction Tool

XY2F-0001

Use this tool to extract a Pin Block from the covers in order to make wiring changes or corrections after the cover has been mounted to the pin block for Connector Assemblies (XS2C/ XS2G, soldering/crimping).

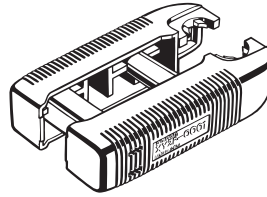

Extraction Procedure

(1) Disconnecting Components

- Disconnect all components on the cap side from the cover.

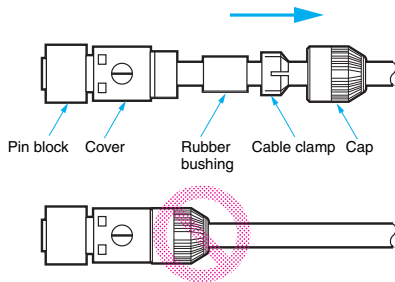

(2) Extracting Pin Block

- Insert the claws of the Tool into the four holes of the cover.

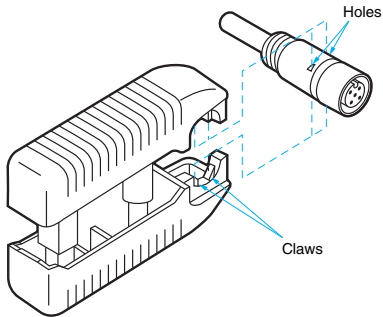

- Make sure that the pin block is outside the Tool.

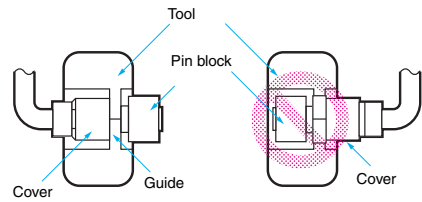

- Press the Tool so that the guides of the Tool are in close contact. Then pull the pin block straight.

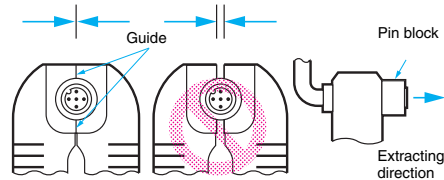

Precaution

- The pin block must not be extracted from the same Connector more than 3 times, otherwise the proper degree of protection of the pin block or Connector will not be maintained.

Assembly Procedure for XS2C/XS2G Connector Assemblies

(1) Connector and Cable External Diameters

- Connectors for 8, 7, 6, 4, and 3 mm diameter Cables (i.e., Cables that are 7 to 8, 6 to 7, 5 to 6, 4 to 5, and 3 to 4 mm in diameter respectively) are available. When assembling a Connector used with a cable, make sure that the external diameter of the Connector is suited to that of the cable.
- A watertight bushing for 6/7 mm diameter Cable has no stripe, that for 8/4 mm-diameter Cable has a single stripe, and that for 3 mm diameter Cable has two stripes.

(2) Component Insertion

Crimping/Soldering Connectors

Straight Connectors

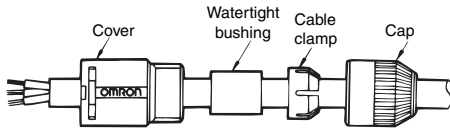

L-shaped Connectors

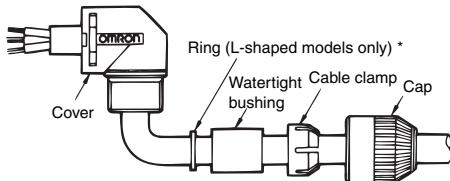

*A ring is not required for Screw-on Connectors.

- As shown in the above illustration, connect the above components to the Cable with its end processed.

Screw-on Connectors

Confirm that you have all of the required parts.

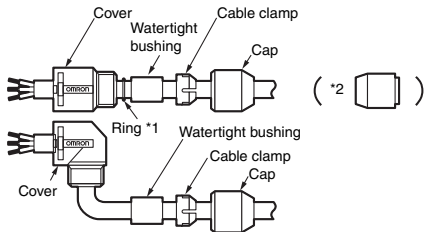

Insulation caps and insulation tubes are included with 5-pole Connectors (XS2C-D5S□ and XS2G-D5S□).

- *1. Rings are not required with 7-mm and 8-mm cables.
- *2. Insert the waterproof bushing for 7-mm and 8-mm cables in the direction shown in the diagram.

(3) Wiring (Processing Cable Ends)

Soldering Connectors

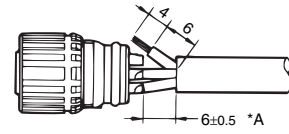

- Strip 10 mm of the Cable sheath and 4 mm of each core.
- Before soldering cores and solder cup pins together, solder-coat each of them.
- The following conditions are recommended for soldering each solder cup pin.
Soldering temperature: $350 \pm 5^\circ\text{C}$
Soldering period: 3 ± 1 s
- The length marked *A should be 6.5 mm max., otherwise the proper degree of protection of the connector will not be maintained.

Crimping Connectors

Crimping

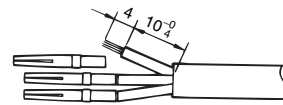

- Strip 14 mm of the Cable sheath and 4 mm of each core.
- Make sure that each core is not damaged and its end strands are not spread out.
- Mount the XY2F-0003 Locator to XY2F-0002 Crimping Tool, both of which are sold separately, and set the selector dial of the Crimping Tool to 8.
- After mounting the crimping pins to the Locator, fully insert the cores to the crimping pins.
- Squeeze the handle of the Crimp Tool to press-fit the cores to the crimping pins.
(Squeeze the handle firmly until the handle automatically returns to the release position.)

Wiring

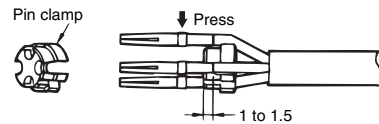

- After press-fitting the cores to the pins, insert the pins into the pin clamp as shown in the illustration. Then make sure that the lead colors correspond to the pin clamp numbers that are identical to the connector pin numbers.

Insertion

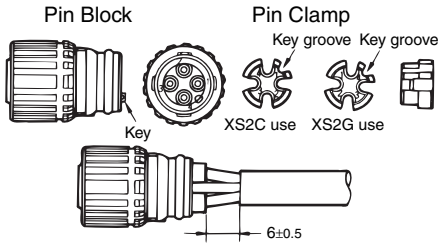

- Tentatively insert the pins to the pin block holes so that the key on the pin block will coincide with the key groove on the pin clamp. Then insert the cable along with the pin clamp.

Screw-on Connectors

Cable End Processing

• Four-pole Connectors

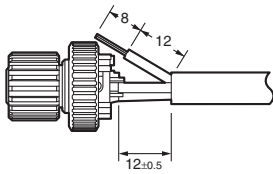

- Loosen the screws on pins 1 to 4 and insert the cores according to the pin numbers.

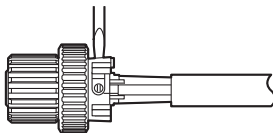

- Use the special Screwdriver (XW4Z-00B) * and tighten the screws securely so that the cores do not pull out (tightening torque: 0.15 to 0.2 N·m).

• Five-pole Connectors

- Strip the cable sheath for a total of 15 mm and strip the core covering for 8 mm for the core to connect to pin 5.

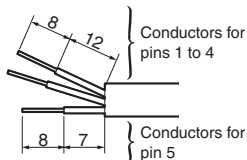

- Connect the core to pin 5 (in the center) first.
- Insert the core from the side of the hold with the tab and tighten the screw securely (tightening torque: Pins 1 to 4: 0.15 to 0.2 N·m, Pins 5: 0.03 to 0.05 N·m), and then cut off the excess wire with wire cutters.

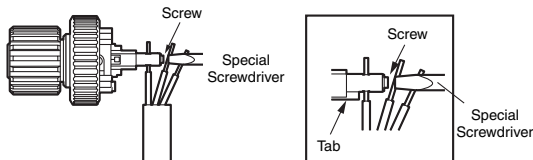

- Bend the cable as shown below, attached the enclosed insulation cap, and then strip the other cores.

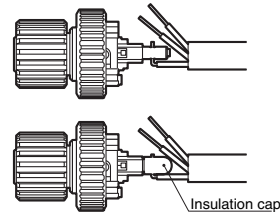

- Connect the cores to pins 1 to 4.

Connecting Shielded Cables to Five-pole Connectors

- Place the insulation tub on the drain line of the shield and connect it to the terminal.
- Tighten the screw and then check visually to see if there is insulation between the cores.

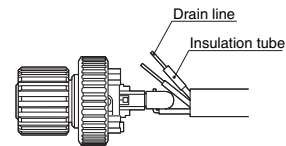

*When tightening the screws, use the dedicated XW4Z-00B Screwdriver that matches with the screw-slot dimensions.

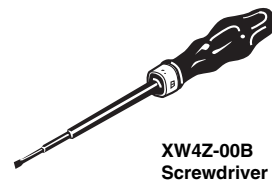

XW4Z-00B
Screwdriver

(4) Inserting Pin Block

Pin Block (Soldering Model) **Cover (Straight Model)**

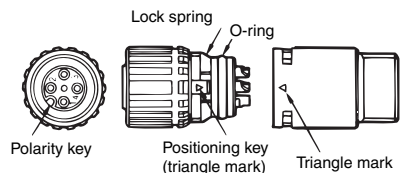

(Crimping Model) **(L-shaped Model)**



- Mount the cover to the pin block so that the triangle mark on the pin block will coincide with the triangle mark on the cover.
- If the cover is used for an L-shaped model, the relationship between the position of the polarity key on the engaged side and cable connection direction will be determined by the direction in which the positioning key is inserted into the cover, which can be rotated by 90°.
- Fully insert the positioning key until the positioning key is hidden by the casing.

**Pin Block
(Screw-mounting Connectors)**

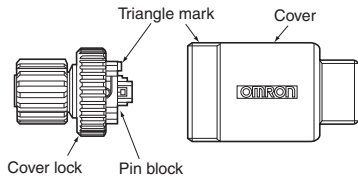

- Align the triangular marks on the pin block and cover and insert the pin block into the cover.
- Press them together firmly (0.39 to 0.49 N·m) until the pin block does not come out of the cover.

(5) Mounting Cap

- After mounting the cover to the pin block and the cover snaps into place, tighten the cap securely by hand within a torque of 0.39 and 0.49 N·m.

Note: If the cap is not tighten securely enough, the degree of protection (IP67) may not be maintained or vibration may cause the cap to become loose. Do not tighten the cap with pliers or similar tools; they may damage the cap.

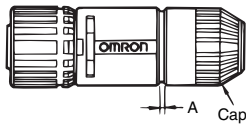

- After fully tightening the cap, length A should be approximately one of the following according to the cable external diameter and the Connector model.

Connector	Cable external diameter (mm)			
	6 mm	5 mm	4 mm	3 mm
For 6-mm-dia. cable	1	0	---	---
For 4-mm-dia. cable	---	2	1	---
For 3-mm-dia. cable	---	---	2	1

(6) After Assembly

- Confirm the insulation between cores after completing assembly.

Recommended Cables

When connecting a commercially available cable to a connector assembly, use a cable with an outside diameter of 3 to 6 mm and core sizes of 0.18 to 0.75 mm² for crimping connectors and 0.5 mm² maximum for soldering connectors.

Connector Arrangement

For safety, when constructing a connection system between a Sensor and panel with a connector, make sure that the connector plug is on the Sensor side and the connector socket is on the panel side (i.e., the female pins are located on the power-supply side).

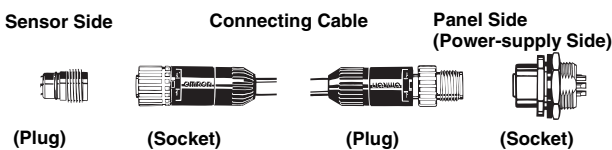

Safety Precautions

Precautions for Correct Use

Do not use the product in atmospheres or environments that exceed product ratings.

Tightening Cap (Connector Assemblies)

1. Do not use pliers to tighten caps, otherwise the caps may be damaged. Be sure to tighten each cap by hand within a torque range between 0.39 and 0.49 N·m.
2. If caps are not tightened securely, the Connectors may not maintain their proper degree of protection (i.e., IP67) or the caps may become loose due to vibration.

Connector Connection and Disconnection

- When connecting or disconnecting Connectors, be sure to hold the Connectors by hand.
- Do not hold the cable part when disconnecting Connectors.
- Connectors mating with sockets must be fully inserted into the sockets. Tighten the thread bracket carefully so that the threads will not be damaged.
- Fully tighten thread bracket within a torque range between 0.39 and 0.49 N·m and be sure that the threads of the opposite parts are hidden by the thread bracket.
- When disconnecting Connectors, be sure to loosen the thread brackets first. Do not loosen the caps.
- Thread brackets must be loosened in the cutout direction.

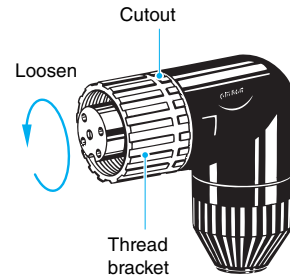

Degree of Protection

- Do not impose external force continuously on the joints of pin blocks and covers, otherwise the Connectors may not keep its proper degree of protection (i.e., IP67).
- The degree of protection of connectors (IP67) is not for a fully watertight structure. Do not use them underwater.
- Connectors are of resin mold construction. Do not impose excessive force on them.

Setup

- Do not make any cable bends near the base of the Unit.
- Any bends made must have a minimum radius of 40 mm.

Terms and Conditions Agreement

Read and understand this catalog.

Please read and understand this catalog before purchasing the products. Please consult your OMRON representative if you have any questions or comments.

Warranties.

(a) Exclusive Warranty. Omron's exclusive warranty is that the Products will be free from defects in materials and workmanship for a period of twelve months from the date of sale by Omron (or such other period expressed in writing by Omron). Omron disclaims all other warranties, express or implied.

(b) Limitations. OMRON MAKES NO WARRANTY OR REPRESENTATION, EXPRESS OR IMPLIED, ABOUT NON-INFRINGEMENT, MERCHANTABILITY OR FITNESS FOR A PARTICULAR PURPOSE OF THE PRODUCTS. BUYER ACKNOWLEDGES THAT IT ALONE HAS DETERMINED THAT THE PRODUCTS WILL SUITABLY MEET THE REQUIREMENTS OF THEIR INTENDED USE.

Omron further disclaims all warranties and responsibility of any type for claims or expenses based on infringement by the Products or otherwise of any intellectual property right. (c) Buyer Remedy. Omron's sole obligation hereunder shall be, at Omron's election, to (i) replace (in the form originally shipped with Buyer responsible for labor charges for removal or replacement thereof) the non-complying Product, (ii) repair the non-complying Product, or (iii) repay or credit Buyer an amount equal to the purchase price of the non-complying Product; provided that in no event shall Omron be responsible for warranty, repair, indemnity or any other claims or expenses regarding the Products unless Omron's analysis confirms that the Products were properly handled, stored, installed and maintained and not subject to contamination, abuse, misuse or inappropriate modification. Return of any Products by Buyer must be approved in writing by Omron before shipment. Omron Companies shall not be liable for the suitability or unsuitability or the results from the use of Products in combination with any electrical or electronic components, circuits, system assemblies or any other materials or substances or environments. Any advice, recommendations or information given orally or in writing, are not to be construed as an amendment or addition to the above warranty.

See <http://www.omron.com/global/> or contact your Omron representative for published information.

Limitation on Liability; Etc.

OMRON COMPANIES SHALL NOT BE LIABLE FOR SPECIAL, INDIRECT, INCIDENTAL, OR CONSEQUENTIAL DAMAGES, LOSS OF PROFITS OR PRODUCTION OR COMMERCIAL LOSS IN ANY WAY CONNECTED WITH THE PRODUCTS, WHETHER SUCH CLAIM IS BASED IN CONTRACT, WARRANTY, NEGLIGENCE OR STRICT LIABILITY.

Further, in no event shall liability of Omron Companies exceed the individual price of the Product on which liability is asserted.

Suitability of Use.

Omron Companies shall not be responsible for conformity with any standards, codes or regulations which apply to the combination of the Product in the Buyer's application or use of the Product. At Buyer's request, Omron will provide applicable third party certification documents identifying ratings and limitations of use which apply to the Product. This information by itself is not sufficient for a complete determination of the suitability of the Product in combination with the end product, machine, system, or other application or use. Buyer shall be solely responsible for determining appropriateness of the particular Product with respect to Buyer's application, product or system. Buyer shall take application responsibility in all cases.

NEVER USE THE PRODUCT FOR AN APPLICATION INVOLVING SERIOUS RISK TO LIFE OR PROPERTY OR IN LARGE QUANTITIES WITHOUT ENSURING THAT THE SYSTEM AS A WHOLE HAS BEEN DESIGNED TO ADDRESS THE RISKS, AND THAT THE OMRON PRODUCT(S) IS PROPERLY RATED AND INSTALLED FOR THE INTENDED USE WITHIN THE OVERALL EQUIPMENT OR SYSTEM.

Programmable Products.

Omron Companies shall not be responsible for the user's programming of a programmable Product, or any consequence thereof.

Performance Data.

Data presented in Omron Company websites, catalogs and other materials is provided as a guide for the user in determining suitability and does not constitute a warranty. It may represent the result of Omron's test conditions, and the user must correlate it to actual application requirements. Actual performance is subject to the Omron's Warranty and Limitations of Liability.

Change in Specifications.

Product specifications and accessories may be changed at any time based on improvements and other reasons. It is our practice to change part numbers when published ratings or features are changed, or when significant construction changes are made. However, some specifications of the Product may be changed without any notice. When in doubt, special part numbers may be assigned to fix or establish key specifications for your application. Please consult with your Omron's representative at any time to confirm actual specifications of purchased Product.

Errors and Omissions.

Information presented by Omron Companies has been checked and is believed to be accurate; however, no responsibility is assumed for clerical, typographical or proofreading errors or omissions.

2017.6

In the interest of product improvement, specifications are subject to change without notice.

OMRON Corporation
Industrial Automation Company

<http://www.ia.omron.com/>

(c)Copyright OMRON Corporation 2017 All Right Reserved.